



AN 841: Signal Tap Tutorial for Intel® Stratix® 10 Partial Reconfiguration Design

Updated for Intel® Quartus® Prime Design Suite: **18.0**



[Subscribe](#)

[Send Feedback](#)

AN-841 | 2018.05.07

Latest document on the web: [PDF](#) | [HTML](#)



Contents

1. Tutorial Overview.....	3
1.1. PR Debug Considerations.....	3
1.2. Tutorial Software and Hardware Requirements.....	4
1.3. Tutorial Design Description.....	5
1.4. Downloading the Tutorial Design.....	5
1.4.1. Tutorial Design Files.....	5
2. Tutorial Walkthrough.....	8
2.1. Step 1: Getting Started.....	9
2.2. Step 2: Preparing the Base Revision.....	9
2.2.1. Preparing the Static Region.....	9
2.2.2. Preparing the Default PR Persona.....	11
2.3. Step 3: Preparing the Implementation Revisions for Debug.....	13
2.4. Step 4: Tapping Signals in the Implementation Persona.....	14
2.5. Step 5: Configuring Data Acquisition.....	16
2.5.1. Add Acquisition Clock.....	16
2.5.2. Add Storage Parameters.....	17
2.6. Step 6: Setting Trigger Conditions.....	18
2.7. Step 7: Generating Programming Files.....	18
2.8. Step 8: Programming the Board.....	19
2.9. Step 9: Performing Data Acquisition.....	20
3. Tutorial Results.....	21
3.1. Waveforms for Slow Implementation.....	21
3.2. Waveforms for Default Implementation.....	21
3.3. Waveforms for Empty Implementation.....	21
4. Document Revision History for AN 841: Signal Tap Tutorial for Intel Stratix 10 Partial Reconfiguration Design.....	22



1. Tutorial Overview

This document demonstrates how to debug a Intel® Stratix® 10 Partial Reconfiguration design with the Signal Tap Logic Analyzer. This application note extends the PR work presented on AN 825: Partially Reconfiguring a Design on Intel Stratix 10 GX FPGA Development Board to a verification environment.

The Signal Tap Logic Analyzer captures and displays real-time signal behavior in an FPGA design, allowing to examine the behavior of internal signals during normal device operation without the need for extra I/O pins or external lab equipment.

Partial Reconfiguration is an advanced design flow that allows you to reconfigure a portion of the FPGA dynamically, while the remaining FPGA design continues to function. You can define multiple personas to occupy a particular design region, without impacting operation in other regions.

The PR support in the Signal Tap Logic Analyzer includes data acquisition in static and PR regions. Moreover, you can debug multiple personas present in a PR region and multiple PR regions.

Related Information

- [Design Debugging with the Signal Tap Logic Analyzer](#)
In *Debug Tools User Guide: Intel Quartus® Prime Pro Edition*
- [Creating a Partial Reconfiguration Design](#)
In *Partial Reconfiguration User Guide: Intel Quartus Prime Pro Edition*
- [AN 825: Partially Reconfiguring a Design on Intel Stratix 10 GX FPGA Development Board](#)

1.1. PR Debug Considerations

Debugging a PR design requires planning. Before compiling, you must decide whether you want to tap signals in the static region, which PR region you want to debug, and which personas in the PR region you want to debug.

To ensure visibility, the debugging fabric must extend to all the regions that you want to tap. The Intel Quartus Prime software performs this extension with debug bridge components: the SLD JTAG Bridge Agent Intel FPGA IP and the SLD JTAG Bridge Host Intel FPGA IP.

To incorporate these components to the design, for each PR region in the design that you want to debug:

1. Instantiate the SLD JTAG Bridge Agent in the static region.
2. Instantiate the SLD JTAG Bridge Host in the PR region of the default persona.
3. Instantiate the SLD JTAG Bridge Host on the implementation revisions that you want to debug.

Figure 1. Debug Fabric in PR Design with Signal Tap

The figure shows in solid outline the entities that you instantiate manually, and in dashed outline the entities that the Compiler instantiates.

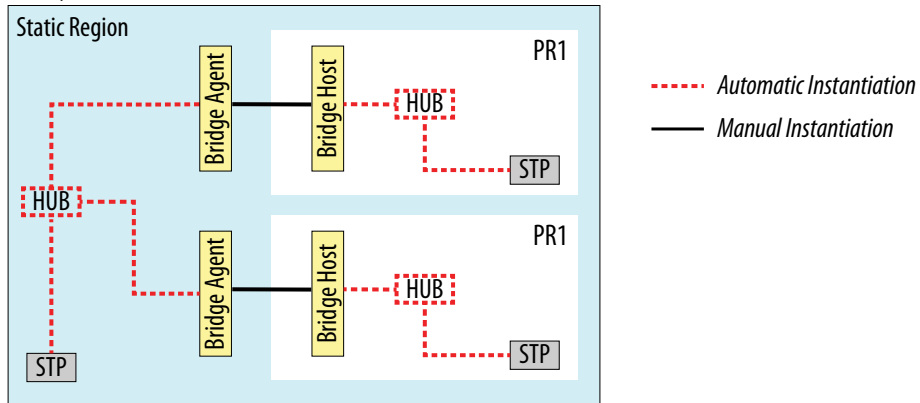

SLD JTAG Bridge Index

The index is an attribute of the SLD JTAG Bridge Agent that uniquely identifies bridge agents present in the design. You can find information regarding the bridge index in the synthesis report (<base revision>.syn.rpt), by looking under **JTAG Bridge Agent Instance Information**. The bridge index for the root partition is always **None**.

Figure 2. JTAG Bridge Agent Instance Information in Synthesis Report

```

5884 +-----+
5885 ; JTAG Bridge Agent Instance Information
5886 +-----+
5887 ; Partition Name ; Associated Host ; JTAG Bridge Agent Hierarchy Name ; Assigned Instance Index ;
5888 +-----+
5889 ; pr_1_block      ; abc          ; pr_region_1|bridge_agent      ; 0
5890 ; pr_2_block      ; def          ; pr_region_2|bridge_agent      ; 0
5891 ; pr_3_block      ; ghi          ; pr_region_3|bridge_agent      ; 0
5892 ; root_partition  ;              ; bridge_agent_1                ; 0
5893 ; root_partition  ;              ; bridge_agent_2                ; 1
5894 ; root_partition  ;              ; bridge_agent_3                ; 2
5895 +-----+
5885,70 88%
  
```

Related Information

[Debugging Partial Reconfiguration Designs Using Signal Tap Logic Analyzer](#)
In *Debug Tools User Guide: Intel Quartus Prime Pro Edition*

1.2. Tutorial Software and Hardware Requirements

To perform this tutorial, you need the following software and hardware:

- The Intel Quartus Prime Pro Edition software version 18.0 or later. The software includes the Signal Tap Logic Analyzer and the Programmer.
- Intel Stratix 10 GX FPGA development kit, or a design board with JTAG connection to the device under test.
- Intel FPGA Download Cable, for communication between the device and the Intel Quartus Prime software.



1.3. Tutorial Design Description

The design for this tutorial consists of one 32-bit counter. At the board level, the design connects the clock to a 50MHz source, and connects the output to four LEDs on the FPGA. Selecting the output from the counter bits in a specific sequence causes the LEDs to blink at a specific frequency.

Figure 3. Flat Reference Design without PR Partitioning

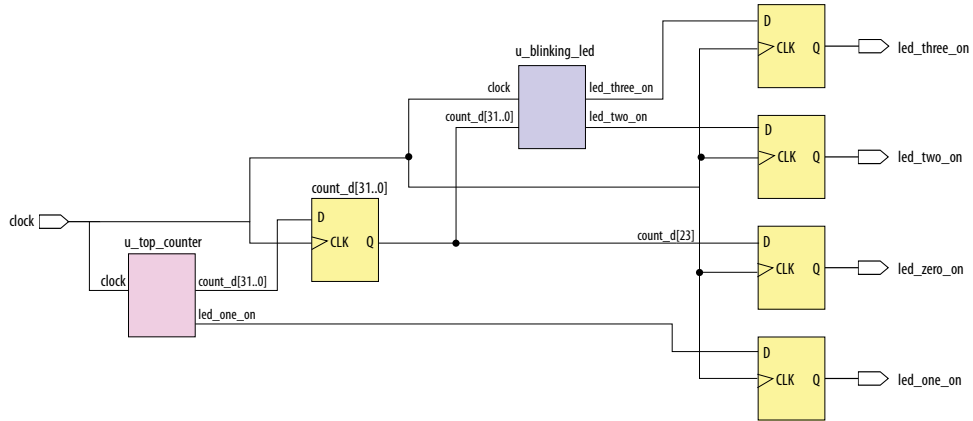

1.4. Downloading the Tutorial Design

The partial reconfiguration tutorial files are available in:

<https://github.com/intel/fpga-partial-reconfig>

To download the tutorial:

1. In the web page, click **Clone or download**, and then click **Download ZIP**.
2. Unzip the `fpga-partial-reconfig-master.zip` file.
3. Navigate to the `tutorials/s10_pcie_devkit_blinking_led_stp` sub-folder to access the design.

1.4.1. Tutorial Design Files

The design folder contains two subfolders: The `start` folder contains the files that you need to follow this tutorial, and the `finish` folder contains the complete set of files you create using this application note. Reference these files at any point during the walkthrough.

Table 1. Description of Tutorial Design Files in start Folder

File Name	Description
<code>top.sv</code>	Top-level file. Contains the flat implementation of the design. This module instantiates the <code>blinking_led</code> sub-partition and the <code>top_counter</code> module.
<i>continued...</i>	



File Name	Description
	This module also instantiates the SLD JTAG Bridge Agent for debugging purposes.
top_counter.sv	Top-level 32-bit counter that controls LED[1] directly. The registered output of the counter controls LED[0], and also powers LED[2] and LED[3] via the blinking_led module.
blinking_led.sdc	Defines the timing constraints for the project.
blinking_led.sv	This module acts as the PR partition. The module receives the registered output of top_counter module, which controls LED[2] and LED[3]. This module also instantiates the SLD JTAG Bridge Agent for debugging the default persona.
blinking_led.qpf	Intel Quartus Prime project file that contains a list of all the revisions in the project.
blinking_led.qsf	Intel Quartus Prime settings file that contains assignments and settings for the base revision of the project.
blinking_led_default.qsf	Contains assignments and settings for the blinking_led_default implementation revision of the project.
blinking_led_slow.qsf	Contains assignments and settings for the blinking_led_slow implementation revision of the project.
blinking_led_empty.qsf	Contains assignments and settings for the blinking led empty of the project.
blinking_led_slow.sv	Slower version of the PR logic. On this version, the led blinks at a slower rate than the default PR persona. The module receives the registered output of top_counter module, which controls LED[2] and LED[3]. This module also instantiates the SLD JTAG Bridge Agent for debugging the default persona.
blinking_led_empty.sv	Empty version of the PR logic. This module holds the outputs at a constant. The module receives the registered output of top_counter module, which controls LED[2] and LED[3]. This module also instantiates the SLD JTAG Bridge Agent for debugging the default persona.



The following Figure shows the list of files in the `finish` folder:

Figure 4. Tutorial Design Files in finish Folder

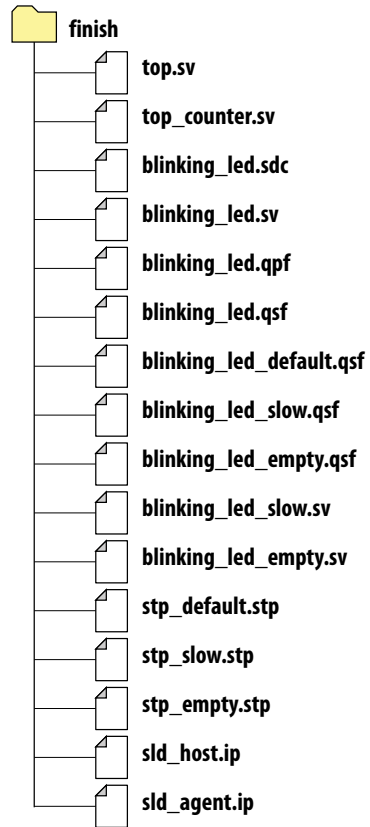



2. Tutorial Walkthrough

This tutorial describes preparing the blinking_led design for debug with the Signal Tap Logic Analyzer.

Note: This Application Note only covers adding Signal Tap debugging capabilities to a PR design. For information about turning a non-PR design to PR, refer to *AN 825: Partially Reconfiguring a Design on Intel Stratix 10 GX FPGA Development Board*.

Process Description

To tap signals in a PR design, you extend the debug fabric to the PR regions when creating the base revision, and then define debug components for the implementation revisions.

Tutorial Steps

This tutorial includes the following steps:

- [Step 1: Getting Started](#) on page 9
- [Step 2: Preparing the Base Revision](#) on page 9
- [Step 3: Preparing the Implementation Revisions for Debug](#) on page 13
- [Step 4: Tapping Signals in the Implementation Persona](#) on page 14
- [Step 5: Configuring Data Acquisition](#) on page 16
- [Step 6: Setting Trigger Conditions](#) on page 18
- [Step 7: Generating Programming Files](#) on page 18
- [Step 8: Programming the Board](#) on page 19
- [Step 9: Performing Data Acquisition](#) on page 20

Related Information

[AN 825: Partially Reconfiguring a Design on Intel Stratix 10 GX FPGA Development Board](#)



2.1. Step 1: Getting Started

To copy the reference design files to your working environment and compile the initial design for this tutorial:

1. Before you begin, [download the tutorial files](#).
2. In your working environment, create a directory named `s10_pcie_devkit_blinking_led_stp`.
3. Copy the downloaded `tutorials/s10_pcie_devkit_blinking_led_stp/start` sub-folder to your working directory.
4. In the Intel Quartus Prime Pro Edition software, click **File** ► **Open Project** and select `blinking_led.qpf`.
5. Click **Processing** ► **Start** ► **Start Analysis and Synthesis**.

Related Information

[Downloading the Tutorial Design](#) on page 5

2.2. Step 2: Preparing the Base Revision

This step extends the debug fabric to the PR regions that you want to debug. To accomplish this goal, you must instantiate the SLD JTAG Bridge Agent in the static region and the SLD JTAG Bridge Host in the default persona of the PR region.

2.2.1. Preparing the Static Region

1. In the IP Catalog (**Tools** ► **IP Catalog**), type SLD JTAG Bridge Agent, and double-click the **SLD JTAG Bridge Agent Intel FPGA IP**.
2. In the **Create IP Variant** dialog box, type `sld_agent` as the file name, and then click **Create**.

Figure 5. Create IP Variant Dialog Box

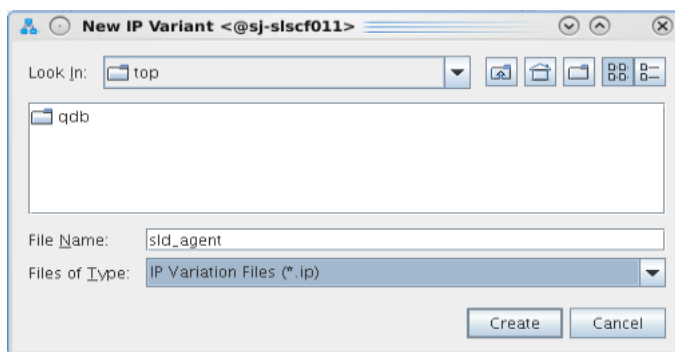

3. In the parameter editor, use the default parameterization for `sld_agent`. Click **Generate HDL...**, and then click **Generate**.

Figure 6. SLD JTAG Bridge Agent Intel FPGA IP Parameters

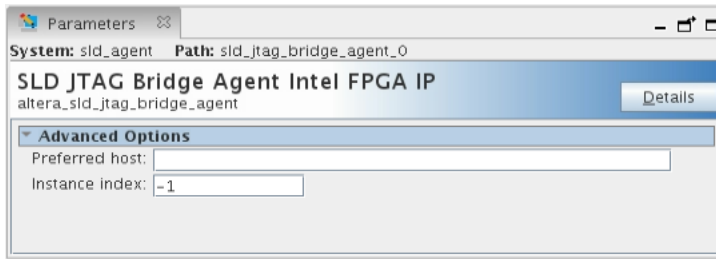

The parameter editor generates the `sld_agent.ip` IP variation file and adds the file to the `blinking_led` project.

4. Close the parameter editor.
5. Verify whether the `sld_agent` IP variant appears in the **IP Components** tab of the Project Navigator.

Figure 7. `sld_agent` IP Variant in Project Navigator

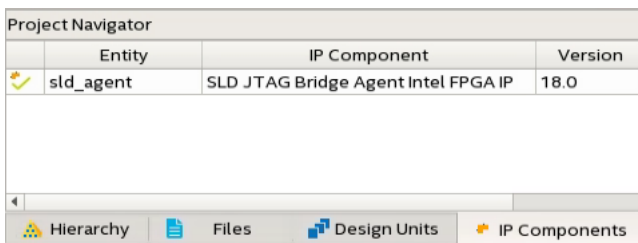

If the IP variant does not appear in the Project Navigator, click **Project > Add/Remove Files in Project**, find the `sld_agent.ip` file, and add to the project.

6. In the `top.sv` file, instantiate the `sld_agent` IP in the base revision by uncommenting the following lines:

```
//=====
//Enable Signal Tap
wire tck;
wire tms;
wire tdi;
wire vir_tdi;
wire ena;
wire tdo;
sld_agent u_sld_agent (
    .tck    (tck),      // output, width = 1, connect_to_bridge_host.tck
    .tms    (tms),      // output, width = 1, .tms
    .tdi    (tdi),      // output, width = 1, .tdi
    .vir_tdi(vir_tdi), //output, width = 1, .vir_tdi
    .ena    (ena),      // output, width = 1, .ena
    .tdo    (tdo)      // input, width = 1, .tdo
);
//=====
```

Related Information

Instantiating the SLD JTAG Bridge Agent

In *Debug Tools User Guide: Intel Quartus Prime Pro Edition*



2.2.2. Preparing the Default PR Persona

In this phase you instantiate the SLD JTAG Bridge Host in the PR region that you want to debug.

1. In the IP Catalog (**Tools > IP Catalog**), type SLD JTAG Bridge Host, and double-click the **SLD JTAG Bridge Host Intel FPGA IP**.
2. In the **Create IP Variant** dialog box, type `sld_host` as the file name, and then click **Create**.

Figure 8. Create IP Variant Dialog Box

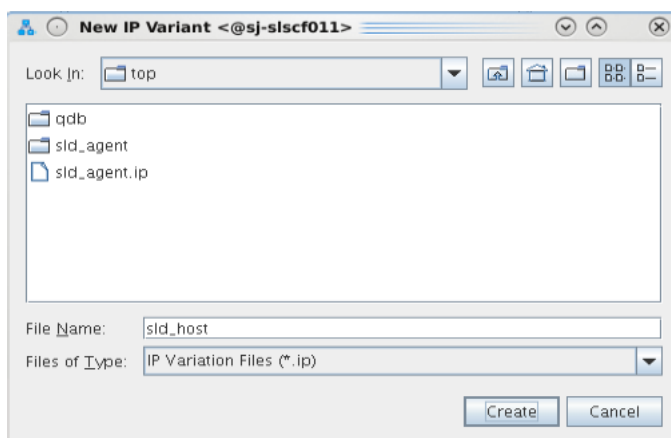

3. In the parameter editor, use the default parameterization for `sld_host`. Click **Generate HDL...**, and then click **Generate**.

Figure 9. SLD JTAG Bridge Host Intel FPGA IP Parameters

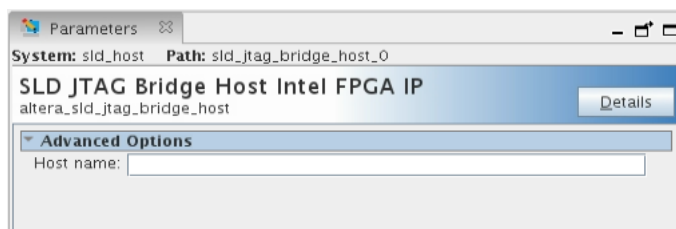

The parameter editor generates the `sld_host.ip` IP variation file and adds the file to the `blinking_led` project.

4. Close the parameter editor.
5. Verify whether the `sld_host` IP variant appears in the **IP Components** tab of the Project Navigator.

Figure 10. sld_host IP Variant in Project Navigator

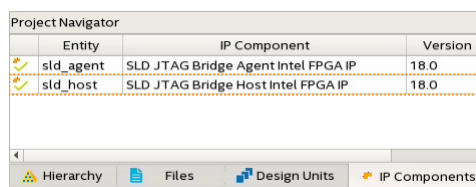



If the IP variant does not appear in the Project Navigator, click **Project > Add/Remove Files in Project**, find the `sld_host.ip` file, and add it to the project.

6. Instantiate the `sld_host` IP in the default persona by uncommenting the following blocks of code from `blinking_led.sv`:

```
//=====
//Uncomment to enable Signal Tap
wire tck;
wire tms;
wire tdi;
wire vir_tdi;
wire ena;
wire tdo;
sld_host u_sld_hostled_two_on (
    .tck    (tck),    // input, width = 1, connect_to_bridge_host.tck
    .tms    (tms),    // input, width = 1,                               .tms
    .tdi    (tdi),    // input, width = 1,                               .tdi
    .vir_tdi(vir_tdi), // input, width = 1,                               .vir_tdi
    .ena    (ena),    // input, width = 1,                               .ena
    .tdo    (tdo)    // output, width = 1,                               .tdo
);
//=====
```

7. Change the instantiation of the persona in `top.sv` to include the `sld_host` ports.

```
blinking_led u_blinking_led (
    .clock      (clock),
    .counter    (count_d),
    //=====
    //Uncomment this block to enable Signal Tap
    .tck    (tck),    // input, width = 1, connect_to_bridge_host.tck
    .tms    (tms),    // input, width = 1,                               .tms
    .tdi    (tdi),    // input, width = 1,                               .tdi
    .vir_tdi(vir_tdi), // input, width = 1,                               .vir_tdi
    .ena    (ena),    // input, width = 1,                               .ena
    .tdo    (tdo),    // output, width = 1,                               .tdo
    //=====
    .led_two_on    (pr_led_two_on),
    .led_three_on  (pr_led_three_on)
);
```

8. Update the port definition of the default PR persona to include the following ports by uncommenting this block of code in the `blinking_led.sv` file:

```
module blinking_led (
    // clock
    input wire clock,
    input wire [31:0] counter,
    //=====
    //Uncomment this block to enable Signal Tap
    input wire tck,
    input wire tms,
    input wire tdi,
    input wire vir_tdi,
    input wire ena,
    output wire tdo,
    //=====
    // Control signals for the LEDs
    output wire led_two_on,
    output wire led_three_on
);
```

Related Information

Instantiating the SLD JTAG Bridge Host

In *Debug Tools User Guide: Intel Quartus Prime Pro Edition*



2.3. Step 3: Preparing the Implementation Revisions for Debug

In this step you instantiate the SLD JTAG Bridge Host and then add a `.stp` file to the implementation revisions that you want to debug.

1. In the Intel Quartus Prime GUI, set `blinking_led_slow` as the current revision.
2. Include `sld_host.ip` as a project file in the `blinking_led_slow` implementation revision.
3. Uncomment the following blocks of code from `blinking_led_slow.sv`:

```
//=====
// Uncomment this block to enable Signal Tap
input wire tck,
input wire tms,
input wire tdi,
input wire vir_tdi,
input wire ena,
output wire tdo,
//=====
//=====
// Uncomment this block to enable Signal Tap
sld_host u_sld_hostled_two_on (
    .tck    (tck),    // input, width = 1, connect_to_bridge_host.tck
    .tms    (tms),    // input, width = 1, .tms
    .tdi    (tdi),    // input, width = 1, .tdi
    .vir_tdi(vir_tdi), // input, width = 1, .vir_tdi
    .ena    (ena),    // input, width = 1, .ena
    .tdo    (tdo)    // output, width = 1, .tdo
);
//=====
```

4. Update the port definition for the PR personas to include the following ports, by uncommenting this block of code in `blinking_led_slow.sv` and `blinking_led_empty.sv` files:

```
module blinking_led_slow (
    // clock
    input wire clock,
    input wire [31:0] counter,
    //=====
    //Uncomment this block to enable Signal Tap
    input wire tck,
    input wire tms,
    input wire tdi,
    input wire vir_tdi,
    input wire ena,
    output wire tdo,
    //=====
    // Control signals for the LEDs
    output wire led_two_on,
    output wire led_three_on
);
```

5. Click **Tools** ► **Signal Tap Logic Analyzer** to open the Signal Tap Logic Analyzer Window.

Figure 11. Signal Tap Logic Analyzer Window

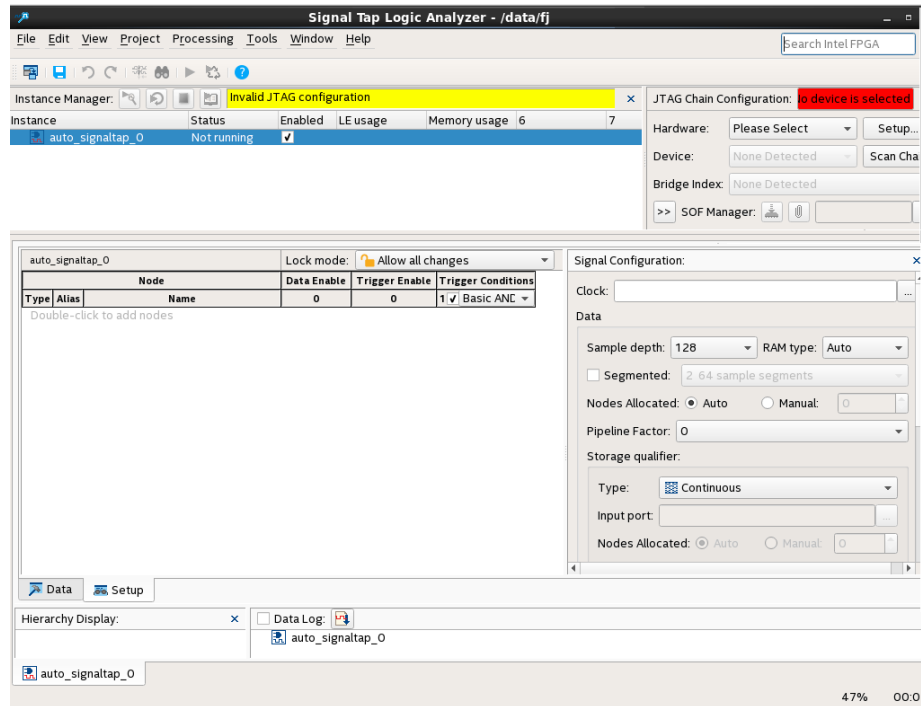

- Click **File** ► **Save As...**, and save the file as `stp_slow.stp`. A dialog box appears prompting you to enable Signal Tap file `stp_slow.stp` for the current project.

Figure 12. Enable `stp_slow.stp` for the Current Project

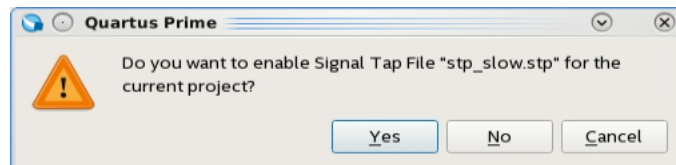

- Click **Yes**.

Repeat these steps for the `blinking_led_default` and the `blinking_led_empty` personas. Use `stp_default.stp` and `stp_empty.stp` for the Signal Tap files.

You can disable Signal Tap in the project by clicking **Assignments** ► **Settings**. In the **Category** pane select Signal Tap Logic Analyzer. Then, turn off **Enable Signal Tap Logic Analyzer**.

Related Information

[Tutorial Design Description](#) on page 5

2.4. Step 4: Tapping Signals in the Implementation Persona

To add signals from the implementation persona to the Signal Tap logic analyzer:



1. Set `blinking_led_slow` as the current revision in the Intel Quartus Prime GUI.
2. Open the `stp_slow.stp` file.
3. Double-click the **Setup** tab to open the Node Finder.
4. Set the following search fields, and then click **Search**

Field	Value
Named	*
Filter	Signal Tap: pre-synthesis
Look in	top u_blinking_led

Figure 13. Search Parameters to Find Signals



This action displays all the nodes that you can probe in this revision.

5. From the **Matching Nodes** list, select `led_three_on`, `led_two_on`, and `counter[2:0]`, `counter[27]`, and `counter[23]`, and then click **>**. This action adds the signals to the **Nodes Found** list.

Figure 14. Signals in Nodes Found List

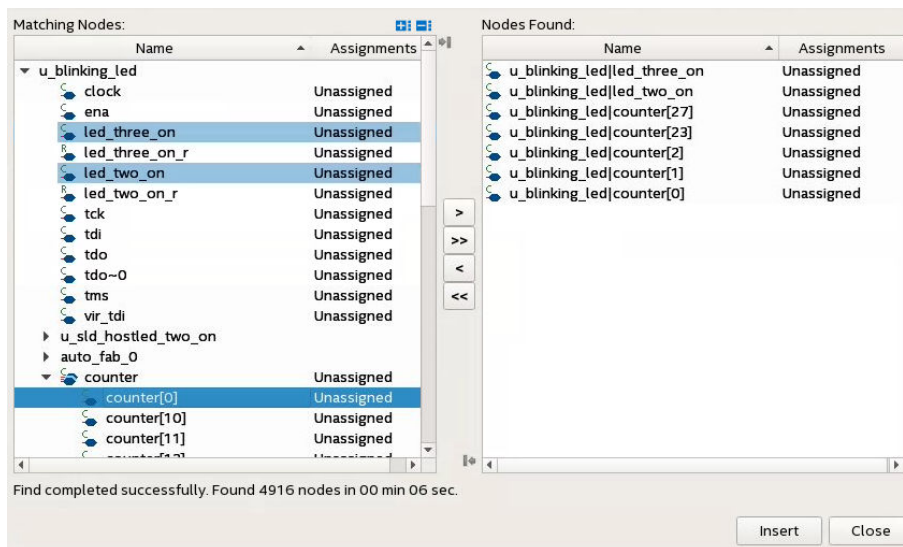

6. Click **Insert**.

The signals now appear in the **Instance Manager** pane of the Signal Tap GUI.

Related Information

Adding Signals to the Signal Tap File

In Debug Tools User Guide: Intel Quartus Prime Pro Edition

2.5. Step 5: Configuring Data Acquisition

You specify the acquisition parameters in the **Signal Configuration** pane of the Signal Tap Logic Analyzer.

Figure 15. Signal Configuration Pane

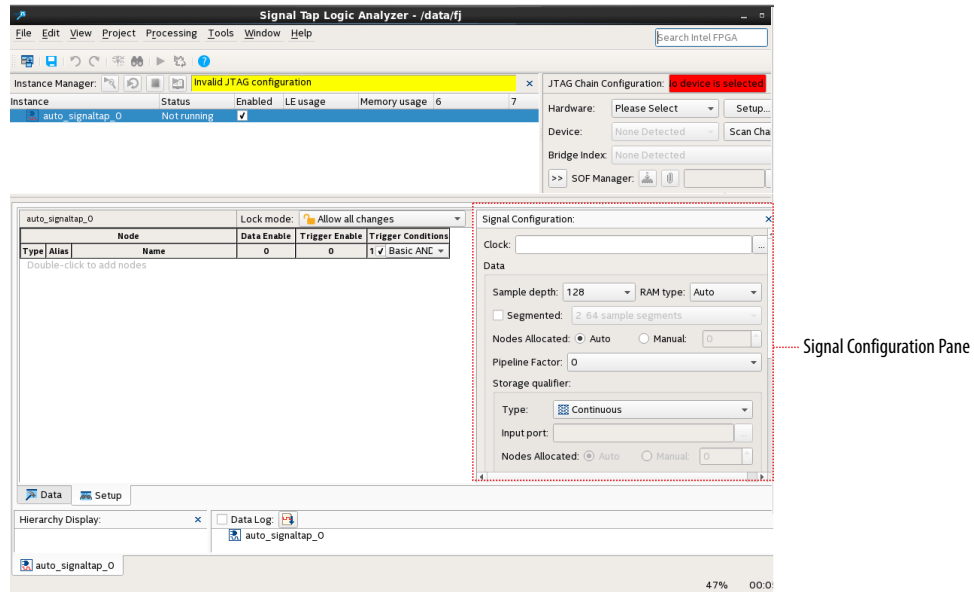

2.5.1. Add Acquisition Clock

Specify the reference clock that Signal Tap uses during acquisition.

Perform the following steps in the **Signal Configuration** pane:

1. Next to **Clock**, click ... to open the **Node Finder**.
2. Set the following search parameters:

Field	Value
<i>Named</i>	*
<i>Look in</i>	top u_blinking_led

Figure 16. Search Parameters to Find the Clock

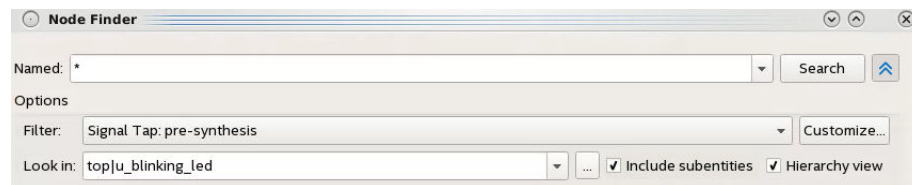

3. Click **Search**.



Figure 17. Select Clock in Node Finder

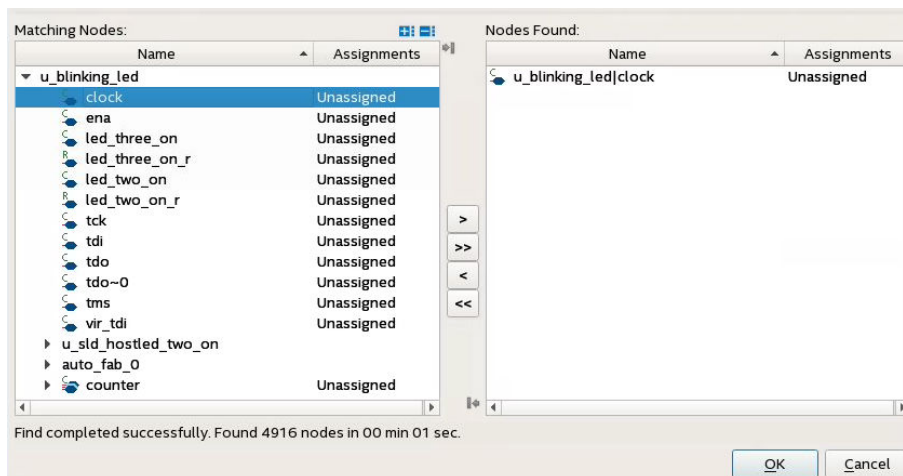

4. Select `clock`, click `>`, and then click **OK**.

2.5.2. Add Storage Parameters

These parameters define the number of samples the Signal Tap Logic Analyzer captures and stores, how to organize this samples, and the location of the sample with respect to the trigger activation.

1. In **Sample Depth**, select 128.
2. In **Storage Qualifier**, set **Type** as **Continuous**.
3. In **Trigger Position**, select **Center Trigger Position**.

Figure 18. Acquisition Settings for Tutorial

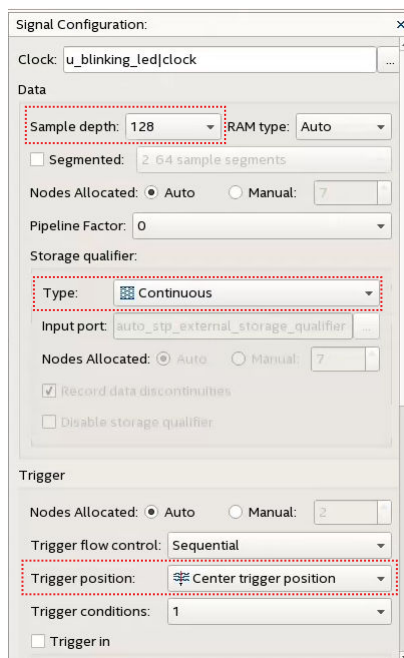

2.6. Step 6: Setting Trigger Conditions

These steps direct the Signal Tap Logic Analyzer to record data only after `u_blinking_led|led_three_on` or `u_blinking_led|led_two_on` does a rising edge transition.

1. In the **Setup** tab of the Signal Tap Logic Analyzer window, turn on the box under the **Trigger Condition** column
2. Open the drop-down menu, and select **Basic OR**.
3. For `u_blinking_led|led_three_on` and `u_blinking_led|led_two_on`, turn on **Trigger Enable** and select **Rising Edge** as the trigger type.
4. For all the other signals, turn off **Trigger Enable**.

Figure 19. Trigger Conditions

Node		Data Enable	Trigger Enable	Trigger Conditions
Type	Alias	7	2	1 Basic OR
		<input checked="" type="checkbox"/>	<input checked="" type="checkbox"/>	
		<input checked="" type="checkbox"/>	<input checked="" type="checkbox"/>	
		<input checked="" type="checkbox"/>	<input type="checkbox"/>	
		<input checked="" type="checkbox"/>	<input type="checkbox"/>	
		<input checked="" type="checkbox"/>	<input type="checkbox"/>	
		<input checked="" type="checkbox"/>	<input type="checkbox"/>	

AND / OR

- AND
- OR
- NAND
- NOR
- XOR
- XNOR
- TRUE
- FALSE

Compare...

- Don't Care
- Low
- Falling Edge
- Rising Edge
- High
- Either Edge

Insert Value...

2.7. Step 7: Generating Programming Files

To generate the `.sof` and `.rbf` files:

1. In the Intel Quartus Prime GUI, click **Processing** ► **Start Compilation** to compile the base revision.
Alternatively, use the following command:

```
quartus_sh --flow compile blinking_led -c blinking_led
```

2. Export the static region by clicking **Project** ► **Export Design Partition**.



Alternatively, use the following command:

```
quartus_cdb -r blinking_led -c blinking_led \  
--export_block root_partition \  
--snapshot final \  
--file blinking_led_static.qdb \  
--include_sdc_entity_in_partition
```

3. Compile the implementation revision in the GUI or command line:

```
quartus_sh --flow compile blinking_led -c blinking_led_slow  
quartus_sh --flow compile blinking_led -c blinking_led_default  
quartus_sh --flow compile blinking_led -c blinking_led_empty
```

Related Information

Compiling the Base Revision and Exporting the Static Region

In *AN 825: Partially Reconfiguring a Design on Intel Stratix 10 GX FPGA Development Board*

2.8. Step 8: Programming the Board

Before you begin:

1. Connect the power supply to the Intel Stratix 10 GX FPGA development board.
2. Connect the USB Blaster cable between your PC USB port and the USB Blaster port on the development board.

Note: This tutorial utilizes the Intel Stratix 10 GX FPGA development board on the bench, outside of the PCIe* slot in your host machine.

To program the design on the board:

1. In the Intel Quartus Prime software, click **Tools > Programmer**.
2. In the Programmer, click **Hardware Setup** and select **USB-Blaster**.
3. Click **Auto Detect** and select the device, **1SG280LU5S1**.
4. Click **OK**. The Intel Quartus Prime software detects and updates the Programmer with the three FPGA chips on the board.
5. Select the 1SG280LU5S1 device, click **Change File** and load the `blinking_led.sof` file.
6. Enable **Program/Configure** for `blinking_led.sof` file.
7. Click **Start** and wait for the progress bar to reach 100%.
8. To program the PR persona that you want to debug, right-click the `blinking_led.sof` file in the Programmer, and click **Add PR Programming File**.
9. Select the `blinking_led_slow.pr_partition.rbf` file.
10. Disable **Program/Configure** for `blinking_led.sof` file.
11. Enable **Program/Configure** for `blinking_led_slow.pr_partition.rbf` file and click **Start**.
12. On the board, verify that two of the LEDs are blinking slower than the other two.

Related Information

Troubleshooting PR Programming Errors

In *Partial Reconfiguration User Guide: Intel Quartus Prime Pro Edition*

2.9. Step 9: Performing Data Acquisition

After loading the appropriate .rbf onto the board, you can start data acquisition on the Signal Tap logic analyzer.

To perform data acquisition:

1. Make sure that the Signal Tap Logic Analyzer loads the .stp file in the current active revision.
2. In the top right corner of the Signal Tap window, set up the JTAG connection to the board with the following options:

Option	Description
Hardware	USB-BlasterII
Device	1SG280L
Bridge Index	0

Figure 20. JTAG Configuration

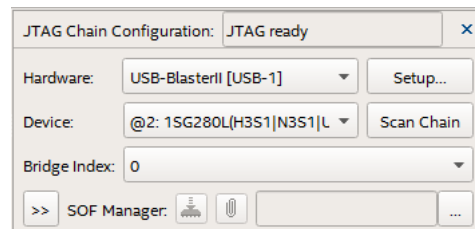

3. On the Signal Tap toolbar, click **Run Analysis** . The analysis may take a few minutes. When the analysis finishes, the Signal Tap Logic Analyzer loads the waveforms to the window.

The following section displays the resultant waveforms for all PR configurations.

3. Tutorial Results

By looking at the data acquisition waveform, you can verify whether the signals behave consistently with your expectations. As a reference, the waveforms include counter[2:0] signals.

Related Information

Tutorial Design Description on page 5

3.1. Waveforms for Slow Implementation

In the Figure, signals led_three_on and led_two_on show a rising edge one clock cycle after counter[27] has a rising edge.

Figure 21. Slow Implementation

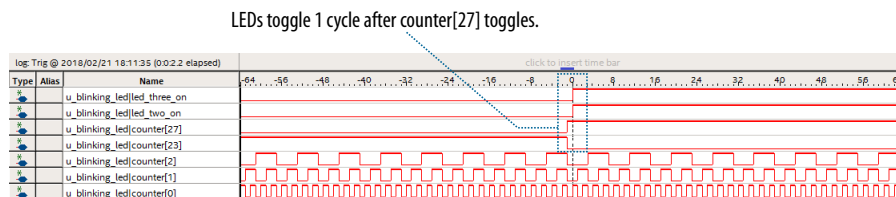

3.2. Waveforms for Default Implementation

Figure 22. Default Implementation

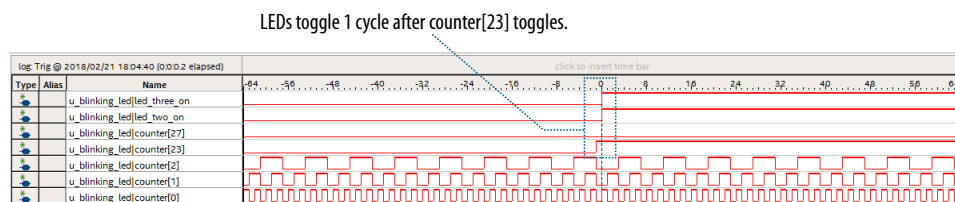

3.3. Waveforms for Empty Implementation

Figure 23. Empty Implementation

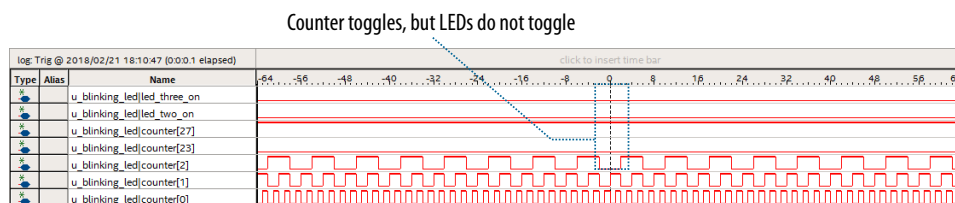

Intel Corporation. All rights reserved. Intel, the Intel logo, Altera, Arria, Cyclone, Enpirion, MAX, Nios, Quartus and Stratix words and logos are trademarks of Intel Corporation or its subsidiaries in the U.S. and/or other countries. Intel warrants performance of its FPGA and semiconductor products to current specifications in accordance with Intel's standard warranty, but reserves the right to make changes to any products and services at any time without notice. Intel assumes no responsibility or liability arising out of the application or use of any information, product, or service described herein except as expressly agreed to in writing by Intel. Intel customers are advised to obtain the latest version of device specifications before relying on any published information and before placing orders for products or services.

*Other names and brands may be claimed as the property of others.

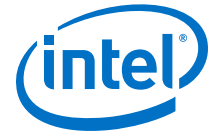

4. Document Revision History for AN 841: Signal Tap Tutorial for Intel Stratix 10 Partial Reconfiguration Design

This document has the following revision history:

Table 2. Document Revision History

Document Version	Intel Quartus Prime Version	Changes
2018.05.07	18.0.0	Initial release.

Intel Corporation. All rights reserved. Intel, the Intel logo, Altera, Arria, Cyclone, Enpirion, MAX, Nios, Quartus and Stratix words and logos are trademarks of Intel Corporation or its subsidiaries in the U.S. and/or other countries. Intel warrants performance of its FPGA and semiconductor products to current specifications in accordance with Intel's standard warranty, but reserves the right to make changes to any products and services at any time without notice. Intel assumes no responsibility or liability arising out of the application or use of any information, product, or service described herein except as expressly agreed to in writing by Intel. Intel customers are advised to obtain the latest version of device specifications before relying on any published information and before placing orders for products or services.

*Other names and brands may be claimed as the property of others.

ISO
9001:2008
Registered